



Ersatzteile passend für
Kühlgeräte



Ersatzteile passend für

TECNODOM

2018

Das komplette Sortiment finden Sie immer aktuell im GEV-Webshop



Heizkörper

Heizkörper für Kältetechnik

Abtauheizungen



GEV-Nr.	420481	Vergl.-Nr.	AF52RESEV0607 RCSE700BTMN
Beschreibung	Heizkörper 360W 230V L 260mm B 75mm H 42mm Anschluss Flachsteckhülse 6,3mm Kabellänge 900mm Rohr ø 8.5mm		

Tauwasserheizungen



GEV-Nr.	420480	Vergl.-Nr.	AF17RESVASC RCVEC92510W
Beschreibung	Heizkörper 150W 230V L 420mm B 70mm Kabellänge 250mm Anschlussabstand 70mm Anschluss Flachstecker 6,3mm Rohr ø 8.5mm		

Heizkabel

Anschluss beidseitig

mit Aderendhülsen



GEV-Nr.	420479	Vergl.-Nr.	AF10RESPO RFPAC5700
Beschreibung	Heizkabel 52W 230V L 5700mm L1 (unbeheizt) 2x730mm L2 (beheizt) 4240mm Silikon ø 2.7mm		

Thermostate

Regel- und Sicherheitsthermostate

CAEM

Regelthermostate

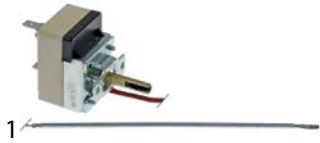

GEV-Nr.	390790	Vergl.-Nr.	HETFR50-280
Beschreibung	Thermostat T.max. 300°C Arbeitsbereich 50-280°C 1-polig 1NO 16A Fühler ø 3mm Fühler L 160mm Kapillarrohr 1450mm Kapillarrohr isoliert 650mm Stopfbuchse Achse ø 6x4,6mm Achslänge 22mm Drehwinkel 270° 250V		

Schalter und Taster

Wippenschalter/-taster

30x22mm



GEV-Nr.	301003	Vergl.-Nr.	AF30INT	
Beschreibung	Wippenschalter Einbaumaß 30x22mm grün 2NO 250V 16A beleuchtet 0-I Anschluss Flachstecker 6,3mm Umgebungstemperatur max. 125/55°C Schutzart IP65			
Zubehör für	301003			
	GEV-Nr.	301036	Vergl.-Nr.	—
	Schutzhaube Innenmaß 30x22mm für Wippenschalter Einbaumaß-mm			

Fühler

Universalfühler

Temperaturfühler



GEV-Nr.	379053	Vergl.-Nr.	ATserie
Beschreibung	Temperaturfühler PTC 1kOhm Kabel PVC Fühler -50 bis +150°C Kabel -10 bis +100°C Fühler ø6x30mm Kabellänge 3m ohne Verschraubung 2-adrig		

Einstechfühler



GEV-Nr.	379549	Vergl.-Nr.	SONCU
Beschreibung	Kerntemperaturfühler PTC 1kOhm Kabel PVC Fühler -50 bis +150°C Kabel -10 bis +100°C Fühler ø6x110mm Kabellänge 3.5m Griff ø 8mm Grifflänge 120x35mm 2-adrig L1 120mm L2 130mm		

Herstellerspezifische Fühler

Einsteckfühler

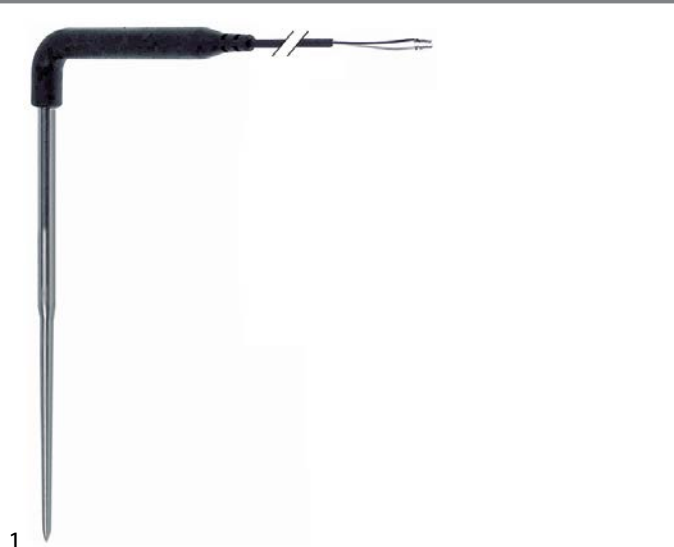

GEV-Nr.	379549	Vergl.-Nr.	SONCU
Beschreibung	Kerntemperaturfühler PTC 1kOhm Kabel PVC Fühler -50 bis +150°C Kabel -10 bis +100°C Fühler ø6x110mm Kabellänge 3.5m Griff ø 8mm Grifflänge 120x35mm 2-adrig L1 120mm L2 130mm		

Elektroniken

Platinen



GEV-Nr.	403887	Vergl.-Nr.	SCDAB3/5T
Beschreibung	Elektronikregler für Tiefkühlschrank L 105mm B 95mm		

Kompressoren

ACC/ZEL

R404a/R507

HMBP 1-phasig

Hohe/Mittlere Verdampfungstemperatur über -20/-15 °C



GEV-Nr.	605068	Vergl.-Nr.	AF82ML45TB AF82ML45TG
Beschreibung	Kompressor Kältemittel R404a/R507 Typ ML45TB 220-240V 50Hz HMBP vollhermetisch 10kg 1/5HP Hubraum 4.5cm³ CSIR H 175.5mmW 192W 246W 309W 382W 465W 557W 659W 771W Test- verfahren ASHRAE		



GEV-Nr.	605014	Vergl.-Nr.	AF82ML80TB
Beschreibung	Kompressor Kältemittel R404a/R507 Typ ML80TB 220-240V 50Hz HMBP vollhermetisch 11.4kg 3/8HP Hubraum 7.57cm³ CSIR H 175.5mmW 261W 346W 446W 561W 691W 835W 993W 1167W Test- verfahren ASHRAE Umgebungstemperatur max. 43°C		





Lüfter

Axiallüfter

Import



GEV-Nr.	601080 ¹	Vergl.-Nr.	VENTILATORECOMP
Beschreibung	Axiallüfter L 119mm B 119mm H 38mm 230VAC 50/60Hz 23/20W Lager Kugellager Anschluss Flachstecker 2,8mm Metall ADDA Lüfterrad ø 110mm Temp.Best. 70°C		
Zubehör für	601080		
	GEV-Nr.	550898	Vergl.-Nr. —
	Anschlusskabel Kabellänge 2000mm Anschluss F 2,8 Anschlussabstand 7.9mm für Axiallüfter		
	GEV-Nr.	692519	Vergl.-Nr. —
	Schutzgitter L 120mm B 120mm Kunststoff		

¹mit Kugellager

Kältelüfter

Kältemotoren Universal

Zubehör

Lüfterräder

Aluminium

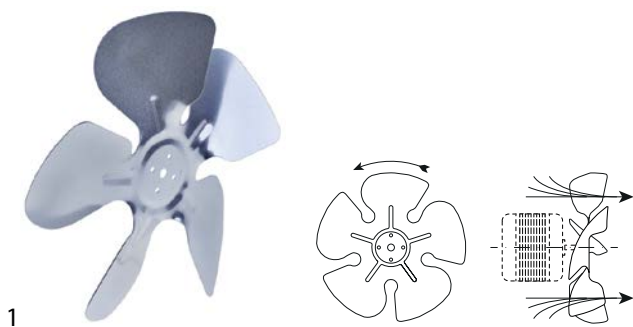

GEV-Nr.	601571	Vergl.-Nr.	AF83VENCOND
Beschreibung	Lüfterrad drückend ø 230mm Lüfterradbefestigung 25.4mm Flügelwinkel 28° B 43mm Aluminium		

Kälteventilatoren komplett

ebm-papst

Serie A4E

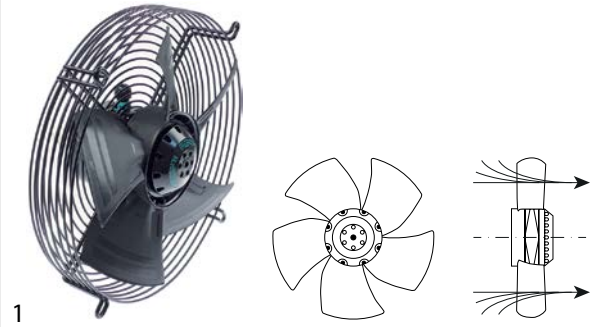

GEV-Nr.	602049	Vergl.-Nr.	VENTBAST
Beschreibung	Ventilator A4E300-AS72-06 Lüfterrad ø 300mm Schaufeln 5 230V 50/60Hz 72/90W ø 340mm BA 265mm 1320/1500U/min Kabellängem ebm-papst		

Querstromlüfter

COPREL

mit vergossenen Spulen



GEV-Nr.	602104	Vergl.-Nr.	N/A
Beschreibung	Querstromlüfter COPREL FFL Walze ø 60mm Walze L 240mm Blechpaketstärke 20mm Motor links 230V/50-60Hz 26W universal Lager Silikon Anschluss Kabel 500mm Leistung 149m ³ /h -10 bis +50°C		



Scharniere

Federscharniere

Universal

INTERKLIMAT

Scharniere

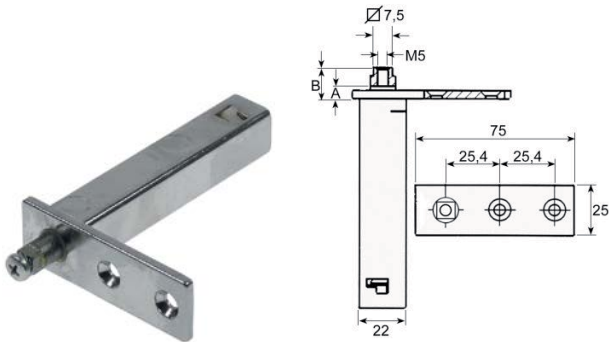

1

GEV-Nr.	690622	Vergl.-Nr.	AF07CERN AF07CERN 10 AFCERN1400
Beschreibung	Federscharnier Serie 28L EP links/rechts L 75mm B 25mm H 103mm A 13mm B 18mm Einbaumaß 22x22mm Aufnahme 7,5x7,5 Kaltgeräte		

Backofenscharniere

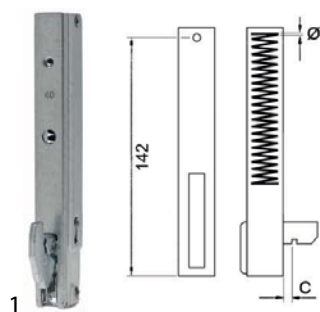

1

GEV-Nr.	700390	Vergl.-Nr.	HCFO3GN7741 HCFO4NE6843 HCFONE595 HCFONEPAST
Beschreibung	Backofenscharnier BA 142mm BA2mm Laschenbefestigungmm Hebellängem Nutabstand 12mm Federstärke 3mm Laschenposition Federlänge 116mm L 170mm EP links/rechts B 22mm		

Zubehör

Sonstige



1

GEV-Nr.	701619	Vergl.-Nr.	TZXXA056SX
Beschreibung	Halter für Scharnier L 120mm		

Roste und Stellschienen

Gitterroste

Universal

ohne Aufkantung



1

GEV-Nr.	970896	Vergl.-Nr.	GRPL600
Beschreibung	Gitterrost B 530mm T 550mm H 10mm Stahl kunststoffbeschichtet Drahtstärke Rahmen 8mm Drahtstärke Längsdrähte 3mm Querstreben 2 grau		

Stellschienen und Träger

Herstellerspezifisch



1

GEV-Nr.	701483	Vergl.-Nr.	GL700
Beschreibung	Stellschienenpaar L-Form L 650mm B 24mm H 28mm EP links/rechts		



1

GEV-Nr.	692619	Vergl.-Nr.	GC700
Beschreibung	Stellschienenpaar U-Form L 650mm B 14mm H 28mm EP links/rechts		



Dichtungen

Kältedichtungen

Steckdichtungen

Profil 9048

Dieses Profil kann auf Wunsch in Sondermaßen gefertigt werden

Mechanik und Gerätezubehör

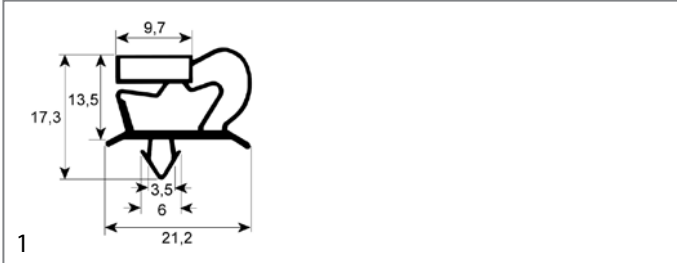

GEV-Nr.	900944	Vergl.-Nr.	GC3CTGN
Beschreibung	Kältedichtung Profil 9048 B 387mm L 177mm Steckmaß		

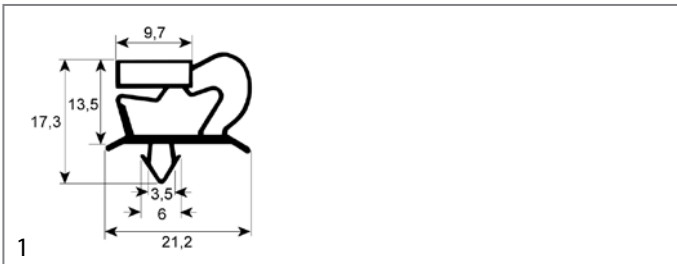

GEV-Nr.	900945	Vergl.-Nr.	GC2CTGN
Beschreibung	Kältedichtung Profil 9048 B 387mm L 292mm Steckmaß		

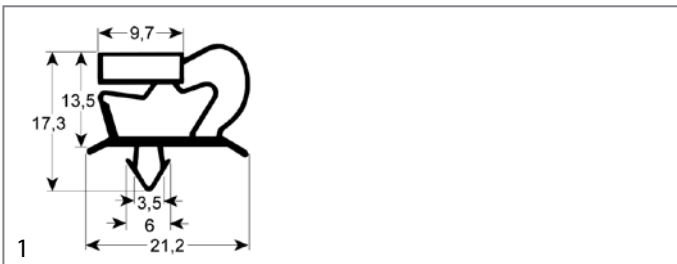

GEV-Nr.	902063	Vergl.-Nr.	GPTGN
Beschreibung	Kältedichtung Profil 9048 B 387mm L 633mm Steckmaß		

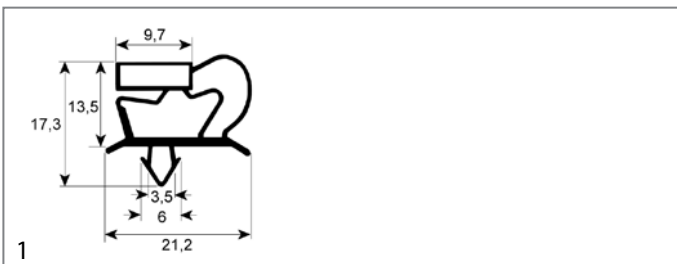

GEV-Nr.	900947	Vergl.-Nr.	GPTPA
Beschreibung	Kältedichtung Profil 9048 B 455mm L 635mm Steckmaß		

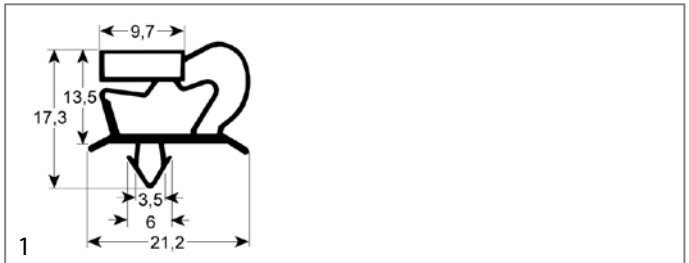

GEV-Nr.	902110	Vergl.-Nr.	GPA400
Beschreibung	Kältedichtung Profil 9048 B 540mm L 1390mm Steckmaß		

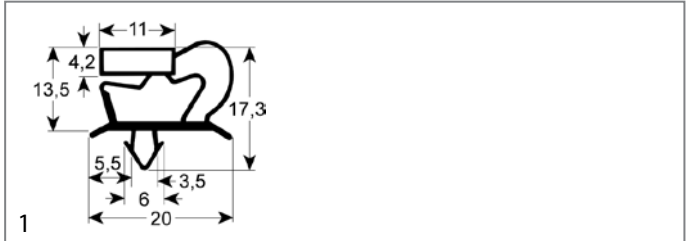

GEV-Nr.	902467	Vergl.-Nr.	GSA
Beschreibung	Kältedichtung Profil 9048 B 621mm L 742mm Steckmaß		

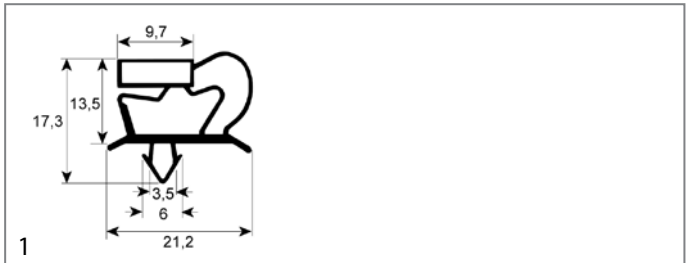

GEV-Nr.	900949	Vergl.-Nr.	AF07-013 AF09GUAPO AF14-013 AF14EKOMBT GPA GPA Pos. 13
Beschreibung	Kältedichtung Profil 9048 B 627mm L 1545mm Steckmaß		

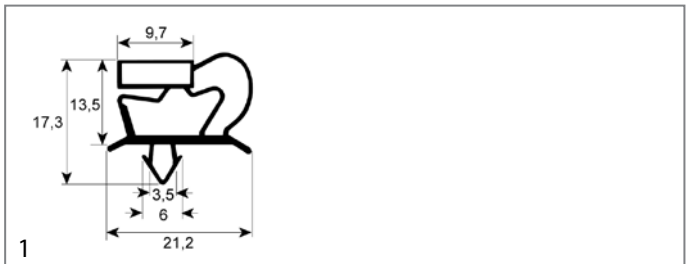

GEV-Nr.	900948	Vergl.-Nr.	AF08GUASP AF09GUASP
Beschreibung	Kältedichtung Profil 9048 B 637mm L 742mm Steckmaß		

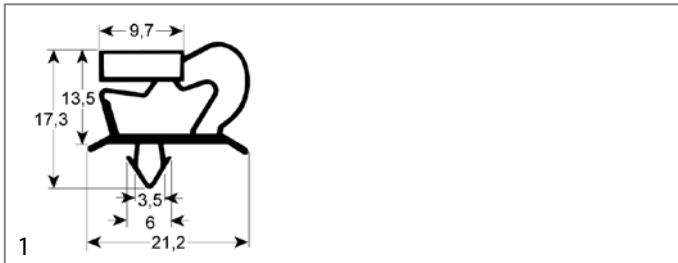

GEV-Nr.	902258	Vergl.-Nr.	N/A
Beschreibung	Kältedichtung Profil 9048 Bmm L 2500mm Steckmaß		

A

Abtauheizungen	2
Axiallüfter	4

B

Backofenscharniere	5
--------------------	---

E

Einsteckfühler	2
----------------	---

F

Federscharniere	5
Fühler	2

G

Gitterroste	5
-------------	---

H

Heizkabel	2
Heizkörper	2
Heizkörper für Kältetechnik	2

K

Kältdichtungen	6
Kältelüfter	4
Kältemotoren Universal	4
Kälteventilatoren komplett	4
Kompressoren	3

L

Lüfter	4
--------	---

Q

Querstromlüfter	4
-----------------	---

R

Roste und Stellschienen	5
-------------------------	---

S

Schalter und Taster	2
Steckdichtungen	6

T

Tauwasserheizungen	2
Temperaturfühler	2
Thermostate	2

U

Universalfühler	2
-----------------	---

W

Wippenschalter/-taster	2
------------------------	---