



GAS



ELEKTRO



WASSER



MECHANIK



WERKZEUG

Ersatzteile passend für

SHARP

Das komplette Sortiment finden Sie immer aktuell im GEV-Webshop



Thermostate

Anlegethermostate

Anlegethermostate



1

GEV-Nr.	390632	Vergl.-Nr.	RTHM-A122WRZZ
Beschreibung	Anlegethermostat LA 23.5mm Abschalttemp. 125°C 1NC 1-poligAV Anschluss F6,3 2-Lochbefestigung		



1

GEV-Nr.	390634	Vergl.-Nr.	RTHM-A120WRE0
Beschreibung	Anlegethermostat LA 23.5mm Abschalttemp. 145°C 1NC 1-polig 16A 250V Anschluss F6,3 2-Lochbefestigung		



1

GEV-Nr.	390635	Vergl.-Nr.	QFS-TA014WRE0
Beschreibung	Anlegethermostat LA 24mm Abschalttemp. 150°C NC 1-polig 15A Anschluss F6,3 2-Lochbefestigung		

Schalter und Taster

Mikroschalter

stiftbetätigt



1

GEV-Nr.	347043	Vergl.-Nr.	QSW-MA086WRE0 QSW-MA111WRE0
Beschreibung	Mikroschalter mit Druckstift 250V 16A 1NC Anschluss Flachstecker 4,8mm Umgebungstemperatur max. 105°C BA 22mm Typ V-16G-2C25 Betätigungskraft: 140g schwarz		

Encoder und Potentiometer



1

GEV-Nr.	401677	Vergl.-Nr.	DPWBFC373WRKZ DPWBFC373WRKZ1
Beschreibung	Encoder für Mikrowellen		



1

GEV-Nr.	401678	Vergl.-Nr.	RVR-BA018WRE0
Beschreibung	Encoder für Mikrowellen		

Lampen

Mikrowellenlampen

Glühlampen



1

GEV-Nr.	359549	Vergl.-Nr.	RLMPTA028WRE0 RLMPTA078WRE0
Beschreibung	Glühlampe Fassung E14 220-240V 25W ø 25mm L 60mm VPE 1 Stück für Mikrowelle		

Magnetrons



1

GEV-Nr.	402121	Vergl.-Nr.	2M240H(L2) RV-MZA299WRE0
Beschreibung	Magnetron Typ 2M240H(L2)		



1

GEV-Nr.	402119	Vergl.-Nr.	2M281-39K 2M281H(L) RV-MZA335WRZZ
Beschreibung	Magnetron Typ 2M281H(L)		



1

GEV-Nr.	402120	Vergl.-Nr.	2M282H(L) RV-MZA322WREZ
Beschreibung	Magnetron Typ 2M282H(L)		

1

GEV-Nr.	402128	Vergl.-Nr.	RTRN-A742WRZZ
Beschreibung	HV-Transformator primär 235V 50Hz Typ RTRN-A742WRZZ für Mikrowellen		

Transformatoren

offene Transformatoren

mit Kabelanschluss

1

GEV-Nr.	402131	Vergl.-Nr.	RTRNPA005WRZZ
Beschreibung	Transformator primär 230VAC sekundär 12VAC 60VA sekundärA H 50mm L 45mm B 74mm Anschluss Kabel 50/60Hz Typ RTRNPA-005WRZZ		

HV-Transformatoren

1

GEV-Nr.	402130	Vergl.-Nr.	RTRN-A717WRZZ
Beschreibung	HV-Transformator primär 230/240V 50Hz Typ RTRN-A717WRZZ für Mikrowellen		

1

GEV-Nr.	402129	Vergl.-Nr.	RTRN-A741WRZZ
Beschreibung	HV-Transformator primär 235V 50Hz Typ RTRN-A741WRZZ für Mikrowellen		

Fühler

Herstellerspezifische Fühler

1

GEV-Nr.	379521	Vergl.-Nr.	FH-HZA070WRE0
Beschreibung	Temperaturfühler Pt100 Kabel Glasseide Fühler -100 bis +450°C Kabel -50 bis +350°C Anschluss kodierter Stecker Gewinde Fühler ø3,5x10mm Kabellänge 0.2m		

Elektroniken

Elektronikzubehör

1

GEV-Nr.	401044	Vergl.-Nr.	GMADIA067WRF0
Beschreibung	Scheibe H 36mm B 82mm Kunststoff		

Gleichrichter

1

GEV-Nr.	401888	Vergl.-Nr.	FW-QZA117WRK0
Beschreibung	Gleichrichter für Mikrowelle		

Platinen

1

GEV-Nr.	401024	Vergl.-Nr.	DPWBFC157WRKZ
Beschreibung	Anzeigeplatine Mikrowelle für Gerät R15 Typ DPWBFC157WRKZ		

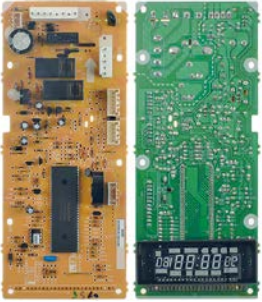

1

GEV-Nr.	401014	Vergl.-Nr.	DPWBFC482WRKZ DPWBFC482WRKZ1
Beschreibung	Anzeigeplatine Mikrowelle für Gerät R23		



1

GEV-Nr.	401043	Vergl.-Nr.	DPWBFC484WRKZ
Beschreibung	Anzeigeplatine Mikrowelle für Gerät R25		



1

GEV-Nr.	401045	Vergl.-Nr.	DPWBFC366WRKZ DPWBFC366WRKZ1
Beschreibung	Anzeigeplatine Mikrowelle für Gerät R25		



1

GEV-Nr.	401048	Vergl.-Nr.	FPWBFA367WRKZ
Beschreibung	Platine Mikrowelle für Gerät R15 Typ FPWBFA367		



1

GEV-Nr.	401046	Vergl.-Nr.	FPWBFA335WRE0
Beschreibung	Platine Mikrowelle für Gerät R23 Typ 06XA335A		

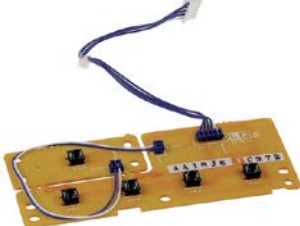

1

GEV-Nr.	401047	Vergl.-Nr.	DPWBFC372WRKZ
Beschreibung	Platine Mikrowelle für Gerät R25 Typ AA18J6FC372		

Tastaturen

Folientastaturen

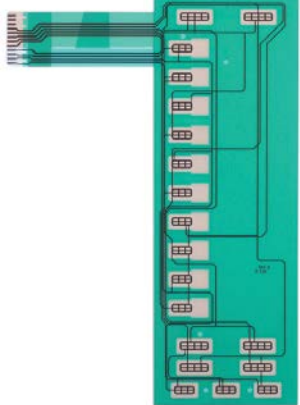

1

GEV-Nr.	402162	Vergl.-Nr.	QSWKA041DRZZ
Beschreibung	Folientastatur L 242mm B 86mm		

Bedienblenden



GEV-Nr.	401866	Vergl.-Nr.	FPNLCB774WRKZ
Beschreibung	Bedienblende		

Lüfter

Radiallüfter

Sonstige



GEV-Nr.	601167	Vergl.-Nr.	FMOTEA482WRKZ
Beschreibung	Radiallüfter 230V Spannung AC 50Hz H1 129mm L1 131mm D1 ø 75mm B1 103mm B2 44mm H2 57mm B3 61mm H3 61mm für Mikrowellen		

Motoren

Getriebemotoren

für Mikrowellen



GEV-Nr.	601969	Vergl.-Nr.	RMOTDA310WRZZ
Beschreibung	Getriebemotor ELENYS Typ SM16 HK36M0HZ 3.5W 220-240V Spannung AC 50-60Hz 10-12U/min Welle ø 6,5x4,5mm für Mikrowellen ø 49mm		

Kondensatoren & Entstörfilter

HV-Kondensator



GEV-Nr.	365087	Vergl.-Nr.	RC-QZA264WRE0 RC-QZA391WRZZ
Beschreibung	HV-Kondensator für Mikrowelle 0.94µF Typ RC-QZA391WRZZ 2300V 50/60Hz 2-fach Anschluss Flachstecker 6,3mm L 94mm H 38mm B 66mm geräteabhängig Aluminium Becherkondensator VPE 1 Stück		



GEV-Nr.	365088	Vergl.-Nr.	RC-QZA320WRZZ RC-QZA393WRZZ
Beschreibung	HV-Kondensator für Mikrowelle 1.07µF Typ RC-QZA393WRZZ 2300V 50/60Hz 2-fach Anschluss Flachstecker 6,3mm L 98mm H 37mm B 65mm geräteabhängig Aluminium Becherkondensator VPE 1 Stück		

Sicherungen

Feinsicherungen



GEV-Nr.	358610	Vergl.-Nr.	QFS-CA026WRZZ
Beschreibung	Feinsicherung Größe ø5x20mm 10A flink Nennspannung 250V VPE 10 Stück		

Diverse



GEV-Nr.	358140	Vergl.-Nr.	QFS-CA017WRE0
Beschreibung	Sicherung Größe ø6,3x32mmmm 017A		

Feinsicherungshalter



GEV-Nr.	358834	Vergl.-Nr.	QFS-IA002WRE0 QFS-IA010WRZZ QFS-IA010WRZZ EHKE57
Beschreibung	Sicherungshalter für Feinsicherung ø6,3x32mm passende Sicherung ø6,3x32mm ø 15mm 0.8A Nennspannung 5KV L 230mm Anschluss F6,3 mit Sicherung 0,8A flink		



			
1			
GEV-Nr.	358006	Vergl.-Nr.	QFS-IA004 QFS-IA004WRE0
Beschreibung	Sicherungshalter für ø6,3x32mm Nennspannung 5KV mit Sicherung 0,6A flink		

Gerätespezifische Bauteile

für Mikrowellen

Gehäuse

Außenteile

			
1			
GEV-Nr.	112544	Vergl.-Nr.	JBTN-A896WRM0
Beschreibung	Druckknopf B 60mm H 26mm silber		

Innenteile

			
1			
GEV-Nr.	691603	Vergl.-Nr.	PCUSUA404WRP0 PCUSUA404WRPO
Beschreibung	Dämpfer L 8mm ø 14mm für Drucktasten		

			
1			
GEV-Nr.	112545	Vergl.-Nr.	JBTN-B263WRTZ
Beschreibung	Druckkastensatz B 91mm H 35mm für Mikrowellen silber		

			
1			
GEV-Nr.	694265	Vergl.-Nr.	FCOVPA032WRKZ FCOVPA036WRKZ Fcovpao32wrkz PCOVPA351WRF0
Beschreibung	Garraumhimmel L 326mm B 323mm H 40mm		

Keramikplatten

			
1			
GEV-Nr.	691039	Vergl.-Nr.	FGLSPA062WRE0
Beschreibung	Keramikplatte L 335mm B 330mm für Mikrowellen		

Türen

Folien

			
1			
GEV-Nr.	691993	Vergl.-Nr.	PSHEPA428WRE0 PSHEPA520WRE0
Beschreibung	Folie L 288mm B 178mm selbstklebend für Tür innen		



Zugfedern

			
1			
GEV-Nr.	691600	Vergl.-Nr.	MSPRCA097WRE0
Beschreibung	Zugfeder ø 9mm für Riegel Gesamtlänge 47mm Drahtstärke ø 1mm		

Griffe und Handräder

Bügelgriffe

			
1			
GEV-Nr.	691598	Vergl.-Nr.	FHNDMA011WRY0
Beschreibung	Betätiger L 173mm B 15mm für Bügelgriff		

				
1				
GEV-Nr.	691597	Vergl.-Nr.	JHNDMA039WRM0 JHNDMA039WRMO	
Beschreibung	Bügelgriff L 195mm H 51mm BA 180mm für Mikrowellen Griff M4			
Ersatzteile für	691597			
	GEV-Nr.	691598	Vergl.-Nr.	FHNDMA-011WRY0
	Betätiger L 173mm B 15mm für Bügelgriff			

Gerätefüße und Endkappen

Steckbare Gerätefüße

			
1			
GEV-Nr.	700391	Vergl.-Nr.	GLEGPA074WRE0
Beschreibung	Gerätefuß ø 20mm H 12mm Einbau ø 7.5mm Gesamthöhe 18mm Kunststoff VPE 1 Stück		

			
1			
GEV-Nr.	358140	Vergl.-Nr.	QFS-CA017WRE0
Beschreibung	Sicherung Größe ø6,3x32mmmm 017A		

Federn

Zugfedern

			
1			
GEV-Nr.	691600	Vergl.-Nr.	MSPRCA097WRE0
Beschreibung	Zugfeder ø 9mm für Riegel Gesamtlänge 47mm Drahtstärke ø 1mm		

			
1			
GEV-Nr.	358006	Vergl.-Nr.	QFS-IA004 QFS-IA004WRE0
Beschreibung	Sicherungshalter für ø6,3x32mm Nennspannung 5KV mit Sicherung 0,6A flink		

Verbrauchsgüter

Sicherungen

Feinsicherungen

			
1			
GEV-Nr.	358610	Vergl.-Nr.	QFS-CA026WRZZ
Beschreibung	Feinsicherung Größe ø5x20mm 10A flink Nennspannung 250V VPE 10 Stück		

A

Anlegethermostate 3,3

F

Feinsicherungen 8

Fühler 4

H

HV-Kondensator 6

K

Kondensatoren & Entstörfiler 6

L

Lampen 3

Lüfter 6

M

Magnetrons 3

Mikroschalter 3

Mikrowellenlampen 3

Motoren 6

R

Radiallüfter 6

S

Schalter und Taster 3

Sicherungen 6,8

T

Thermostate 3

Transformatoren 4

V

Verbrauchsgüter 8