



GAS



ELEKTRO



WASSER



MECHANIK



WERKZEUG

Ersatzteile passend für

GALANZ

Das komplette Sortiment finden Sie immer aktuell im GEV-Webshop

Thermostate

Anlegethermostate

Anlegethermostate

			
1			
GEV-Nr.	390869	Vergl.-Nr.	253099000143 GMW1025-C19 P100M25ASL-H4-C19 SEE250H4H-SABCOG-C19
Beschreibung	Anlegethermostat LA 23.5mm Abschalttemp. 140°C 1NC 1-polig 10A 250V Anschluss F4,8 VPE 1 Stück		

			
1			
GEV-Nr.	390867	Vergl.-Nr.	253099000224 GMW1025-C07 GMW1030-C07 P100M25ASL-H4-C07 P180M30ASL-YL-C07 SEE250H4H-SABCOG-C07 SEE30FYLH-SABCOG-C07
Beschreibung	Anlegethermostat LA 23.5mm Abschalttemp. 180°C 1NC 1-polig 10A 250V Anschluss F4,8 VPE 1 Stück		

			
1			
GEV-Nr.	390868	Vergl.-Nr.	253099000172 GMW1030-C19 P180M30ASL-YL-C19 SEE30FYLH-SABCOG-C19
Beschreibung	Anlegethermostat LA 23.5mm Abschalttemp. 180°C 1NC 1-polig 10A 250V Anschluss F4,8 VPE 1 Stück		

Schalter und Taster





Mikroschalter

stiftbetätigt

			
1			
GEV-Nr.	347799	Vergl.-Nr.	253039000003 GMW1025-C09 GMW1030-C09 P100M25ASL-H4-C09 P180M30ASL-YL-C09 SEE250H4H-SABCOG-C09 SEE30FYLH-SABCOG-C09 W-15-102-C
Beschreibung	Mikroschalter mit Druckstift 250V 15A 1CO Anschluss Flachstecker 4,8mm Umgebungstemperatur max. 105°C BA 22mm Typ W-15-102C Betätigungskraft: 180g weiß		

			
1			
GEV-Nr.	347798	Vergl.-Nr.	253039000010 GMW1025-C10 GMW1025-C11 GMW1030-C10 GMW1030-C11 P100M25ASL-H4-C10 P180M30ASL-YL-C10 P180M30ASL-YL-C11 SEE250H4H-SABCOG-C11 SEE30FYLH-SABCOG-C10 SEE30FYLH-SABCOG-C11 W-15-302C
Beschreibung	Mikroschalter mit Druckstift 250V 15A 1NO Anschluss Flachstecker 4,8mm L 20mm L2 22mm Umgebungstemperatur max. 105°C BA 22mm Typ W-15-302C Betätigungskraft: 200g weiß		

Zubehör

			
1			
GEV-Nr.	347797	Vergl.-Nr.	223109000105 GMW1030-P23 P180M30ASL-YL-P23 SEE30FYLH-SABCOG-P23
Beschreibung	Halterung für Mikroschalter L 165mm B 65mm VPE 1 Stück		
Zubehör für	347797		
			
	GEV-Nr.	347794	Vergl.-Nr.
			223119000028 GMW1030-P247 P180M30ASL-YL-P247 SEE30FYLH-SABCOG-P247
	Hebel für Mikroschalter L 28mm klein ID ø 5mm B 22mm VPE 1 Stück		
			
	GEV-Nr.	347795	Vergl.-Nr.
			223119000027 GMW1030-P246 P180M30ASL-YL-P246 SEE30FYLH-SABCOG-P246
	Hebel für Mikroschalter L 45mm mittel ID ø 5mm B 22mm VPE 1 Stück		
			
	GEV-Nr.	347796	Vergl.-Nr.
			223119000026 GMW1030-P245 P180M30ASL-YL-P245 SEE30FYLH-SABCOG-P245
	Hebel für Mikroschalter L 63mm groß ID ø 5mm B 22mm VPE 1 Stück		

			
1			
GEV-Nr.	347794	Vergl.-Nr.	223119000028 GMW1030-P247 P180M30ASL-YL-P247 SEE30FYLH-SABCOG-P247
Beschreibung	Hebel für Mikroschalter L 28mm klein ID ø 5mm B 22mm VPE 1 Stück		

 <p>1</p>			
GEV-Nr.	347795	Vergl.-Nr.	223119000027 GMW1030-P246 P180M30ASL-YL-P246 SEE30FYLH-SABCOG-P246
Beschreibung	Hebel für Mikroschalter L 45mm mittel ID ø 5mm B 22mm VPE 1 Stück		

 <p>1</p>			
GEV-Nr.	347796	Vergl.-Nr.	223119000026 GMW1030-P245 P180M30ASL-YL-P245 SEE30FYLH-SABCOG-P245
Beschreibung	Hebel für Mikroschalter L 63mm groß ID ø 5mm B 22mm VPE 1 Stück		

Lampen

Mikrowellenlampen

Fassungen

 <p>1</p>			
GEV-Nr.	357141	Vergl.-Nr.	253079000023 GMW1030-P21 P180M30ASL-YL-P21 SEE30FYLH-SABCOG-P21
Beschreibung	Lampenfassung Fassung E14 250V ø 26mm L 37mm Anschluss Flachstecker 4,8mm BA 40mm für Mikrowelle Halterlänge 52mm Kunststoff VPE 1 Stück		

Glühlampen

 <p>1</p>			
GEV-Nr.	357142	Vergl.-Nr.	253079000050 GMW1030-C06 P180M30ASL-YL-C06 SEE30FYLH-SABCOG-C06
Beschreibung	Glühlampe Fassung E14 230V 20W ø 22mm L 58mm VPE 1 Stück Glas L 33mm		

 <p>1</p>			
GEV-Nr.	357175	Vergl.-Nr.	253079000039 GMW1025-C06 P100M25ASL-H4-C06 SEE250H4H-SABCOG-C06
Beschreibung	Glühlampe Fassung E14 230V 20W ø 25mm L 63mm VPE 1 Stück Glas L 37mm		

Leistungshalbleiter

Zubehör

Dioden

Hochspannungsdioden

 <p>1</p>			
GEV-Nr.	403185	Vergl.-Nr.	GMW1030-C45 P180M30ASL-YL-C45 SEE30FYLH-SABCOG-C45
Beschreibung	HV-Diode Typ RG304 Anschluss F4,8mm / Öse M4 für Mikrowelle VPE 1 Stück		

 <p>1</p>			
GEV-Nr.	403261	Vergl.-Nr.	253089000101 GMW1025-C02 P100M25ASL-H4-C02 SEE250H4H-SABCOG-C02
Beschreibung	HV-Diode Typ RG501 Anschluss F6,3mm / Öse M4 Kabellängem für Mikrowelle VPE 1 Stück		

Magnetrons

 <p>1</p>			
GEV-Nr.	403173	Vergl.-Nr.	253017000051 GMW1025-C08 P100M25ASL-H4-C08 SEE250H4H-SABCOG-C08
Beschreibung	Magnetron Typ 2M248(JT)		

1

GEV-Nr.	403259	Vergl.-Nr.	GMW1030-C08 M24FB-610A P180M30ASL-YL-C08 SEE30FYLH-SABCOG-C08
Beschreibung	Magnetron Typ M24FB-610A für Mikrowelle passend für GALANZ		

Elektroniken

Elektronikzubehör



1

GEV-Nr.	551213	Vergl.-Nr.	223249000078 GMW1030-P65 P180M30ASL-YL-P65 SEE30FYLH-SABCOG-P65
Beschreibung	Halterung für Platine L 125mm B 80mm Materialstärke 3mm Kunststoff VPE 1 Stück		

Transformatoren

HV-Transformatoren



1

GEV-Nr.	403258	Vergl.-Nr.	253029000697 95244XC-5 GAL-900E-4 P180M30ASL-YL-C12 SEE30FYLH-SABCOG-C12
Beschreibung	HV-Transformator primär 230-240V 50Hz Typ 95244XC-5 für Mikrowellen		



1

GEV-Nr.	403737	Vergl.-Nr.	253029000698 95244XC-7 GMW1030-C12
Beschreibung	HV-Transformator primär 230-240V 50Hz Typ 95244XC-7 für Mikrowellen		



1

GEV-Nr.	403257	Vergl.-Nr.	253029000256 GAL-1000E-1G GMW1025-C12 P100M25ASL-H4-C12 SEE250H4H-SABCOG-C12
Beschreibung	HV-Transformator primär 230-240V 50Hz Typ GAL-1000E-1G für Mikrowelle		

Platinen



1

GEV-Nr.	403529	Vergl.-Nr.	263019008956 GMW1025-C17 P100M25ASL-H4-C17 SEE250H4H-SABCOG-C17
Beschreibung	Anzeigeplatine Mikrowelle für Gerät GMW1025 L 160mm B 85mm Kabellänge 200mm für Mikrowelle		



1

GEV-Nr.	403184	Vergl.-Nr.	263029001216 GMW1030-C04 P180M30ASL-YL-C04 SEE30FYLH-SABCOG-C04
Beschreibung	Netzfilter für Mikrowelle Typ GMW1030 250V 50/60Hz Leiter 2 Platine Anschluss Flachstecker 6,3mm L 90mm H 20mm B 70mm Platine VPE 1 Stück Kabellänge 130mm		



1

GEV-Nr.	403188	Vergl.-Nr.	263029001088 GMW1025-C04 P100M25ASL-H4-C04 SEE250H4H-SABCOG-C04
Beschreibung	Netzfilter Mikrowelle für GMW1025 250V 50/60Hz Leiter 2 Platine Anschluss Flachstecker 4,8mm L 80mm H 20mm B 40mm Platine VPE 1 Stück Kabellänge 120mm Typ DNV-0818A-5		

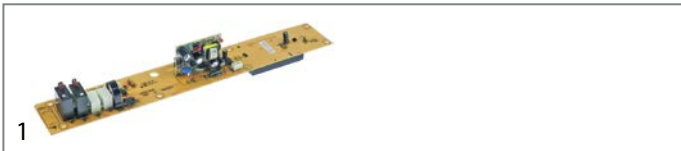

GEV-Nr.	403168	Vergl.-Nr.	GMW1030-C17 old P180M30ASL-YL-C17 old SEE30FYLH-SABCOG-C17 old
Beschreibung	Steuerplatine Mikrowelle für Gerät GMW1030 L 335mm B 50mm mit Anzeige		

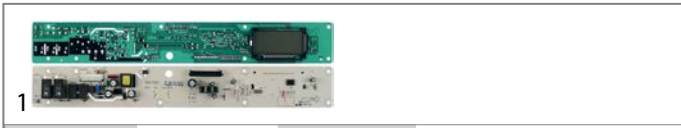

GEV-Nr.	403653	Vergl.-Nr.	263019008957 GMW1030-C17 P180M30ASL-YL-C17 SEE30FYLH-SABCOG-C17
Beschreibung	Steuerplatine Mikrowelle für Gerät GMW1030 L 375mm B 50mm mit Anzeige		

Tastaturen

Folientastaturen



GEV-Nr.	403187	Vergl.-Nr.	253069002692 GMW1025-C18 P100M25ASL-H4-C18 SEE250H4H-SABCOG-C18
Beschreibung	Folientastatur Mikrowelle für Gerät GMW1025 2-teilig Tasten 15 VPE 1 Stück L 164mm B 70mm		

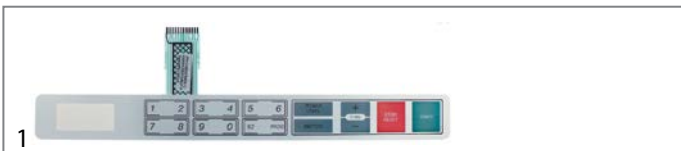

GEV-Nr.	403186	Vergl.-Nr.	253069004090 GMW1030-C18 P180M30ASL-YL-C18 SEE30FYLH-SABCOG-C18
Beschreibung	Folientastatur Mikrowelle Tasten 18 VPE 1 Stück L 386mm B 42mm		

Lüfter

Heißluftmotoren

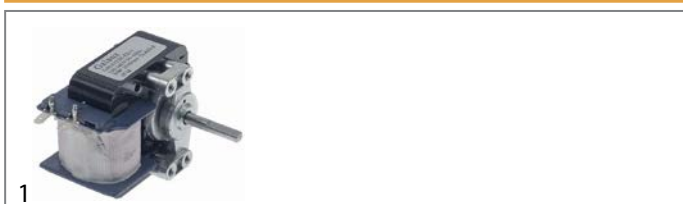

GEV-Nr.	601865	Vergl.-Nr.	278009000143 GAL6125E-ZD-1 GMW1030-C05 P180M30ASL-YL-C05 SEE30FYLH-SABCOG-C05
Beschreibung	Lüftermotor 220-240V 50/60Hz 0.036kW 2500U/min D1 ø 6mm Leistungsaufnahme 18W bei 50Hz 2600U/min Abflachungslänge 18mm		

Heißluftventilatoren

Weitere

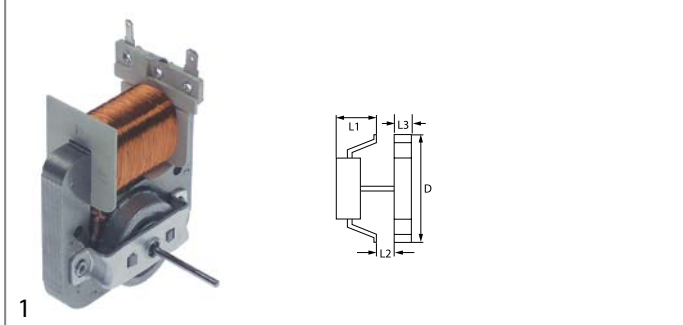

GEV-Nr.	601838	Vergl.-Nr.	278009000033 GMW1025-C05 P100M25ASL-H4-C05 SEE250H4H-SABCOG-C05
Beschreibung	Lüftermotor 220-240V 18W 2500U/min L1 33mm L2 12mm L3 15mm L4mm Lüfterrad ø 120mm Achse 2x2,5mm GALANZ Typ GAL6309E(30)-ZD VPE 1 Stück		

Zubehör

Lüfterräder für Heißluftventilatoren



GEV-Nr.	601839	Vergl.-Nr.	223149000014 GMW1025-P06 P100M25ASL-H4-P06 SEE250H4H-SABCOG-P06
Beschreibung	Lüfterrad ø 120mm B 32mm Achsaufnahme ø 2x2,5mm Kunststoff Schaufeln 4 VPE 1 Stück		



Sonstiges

			
1			
GEV-Nr.	601840	Vergl.-Nr.	22313900011 GMW1025-P05
Beschreibung	Halterung ø 130mm L 135mm B 130mm für Heißluftventilator VPE 1 Stück		

Radiallüfter

Zubehör

Lüfterräder für Radiallüfter

			
1			
GEV-Nr.	601837	Vergl.-Nr.	223999000174 GMW1030-P272 P180M30ASL-YL-P272 SEE30FYLH-SABCOG-P272
Beschreibung	Lüfterrad für Radiallüfter ø 96mm Achsaufnahme 4x5mm H 49mm Schaufeln 40 Kunststoff VPE 1 Stück		

Motoren

Getriebemotoren

für Mikrowellen

			
1			
GEV-Nr.	601867	Vergl.-Nr.	27801900017 GMW1025-C100 P100M25ASL-H4-C100 SEE250H4H-SABCOG-C100
Beschreibung	Getriebemotor GALANZ Typ GAL-33-30-TD(B) 4W 30V Spannung AC 50/60Hz 33/40U/min Welle ø 6x3,5mm für Mikrowelle VPE 1 Stück		

			
1			
GEV-Nr.	601828	Vergl.-Nr.	278009000128 GMW1030-C100 P180M30ASL-YL-C100 SEE30FYLH-SABCOG-C100
Beschreibung	Getriebemotor SYNCHRONOUS MOTOR Typ SM-16E 3W 220-240V Spannung AC 50/60Hz 30/36U/min Welle ø 6x3,5mm		

Kondensatoren & Entstörfilter

Filter

Netzfilter

ohne Gehäuse

			
1			
GEV-Nr.	403184	Vergl.-Nr.	263029001216 GMW1030-C04 P180M30ASL-YL-C04 SEE30FYLH-SABCOG-C04
Beschreibung	Netzfilter für Mikrowelle Typ GMW1030 250V 50/60Hz Leiter 2 Platine Anschluss Flachstecker 6,3mm L 90mm H 20mm B 70mm Platine VPE 1 Stück Kabellänge 130mm		

			
1			
GEV-Nr.	403188	Vergl.-Nr.	263029001088 GMW1025-C04 P100M25ASL-H4-C04 SEE250H4H-SABCOG-C04
Beschreibung	Netzfilter Mikrowelle für GMW1025 250V 50/60Hz Leiter 2 Platine Anschluss Flachstecker 4,8mm L 80mm H 20mm B 40mm Platine VPE 1 Stück Kabellänge 120mm Typ DNV-0818A-5		

HV-Kondensator

			
1			
GEV-Nr.	365158	Vergl.-Nr.	253059000130 GMW1030-C03 P180M30ASL-YL-C03 SEE30FYLH-SABCOG-C03
Beschreibung	HV-Kondensator für Mikrowelle 1.05µF Typ CH85-21105 2100V 50/60Hz 2-fach Anschluss Flachstecker 6,3mm L 90mm H 33mm B 52mm geräteabhängig Aluminium Becherkondensator VPE 1 Stück ømm		



			
1			
GEV-Nr.	365159	Vergl.-Nr.	253059000142 GMW1025-C03 P100M25ASL-H4-C03 SEE250H4H-SABCOG-C03
Beschreibung	HV-Kondensator für Mikrowelle 1.15µF Typ CH85-21115 2100V 50/60Hz 2-fach Anschluss Flachstecker 4,8mm L 105mm H 33mm B 52mm geräteabhängig Aluminium Becherkondensator VPE 1 Stück		

Elektrozubehör

Kabel

Gerätezuleitungen

			
1			
GEV-Nr.	551232	Vergl.-Nr.	253159002607 GMW1025-C14 P100M25ASL-H4-C14 SEE250H4H-SABCOG-C14
Beschreibung	Gerätezuleitung CEE7/7 1mm ² max 500V 1.5m VPE 1 Stück Anschluss Flachstecker 6,3mm schwarz		

Kabelbäume

			
1			
GEV-Nr.	694615	Vergl.-Nr.	253169000472 GMW1025-C13 P100M25ASL-H4-C13 SEE250H4H-SABCOG-C13
Beschreibung	Kabelbaum für Mikrowelle L 800mm VPE 1 Stück		

Gerätespezifische Bauteile

für Mikrowellen





Elektro

Displays

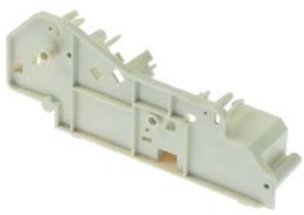

			
1			
GEV-Nr.	692457	Vergl.-Nr.	243029001240 GMW1030-P40 P180M30ASL-YL-P40 SEE30FYLH-SABCOG-P40
Beschreibung	Scheibe für Display Plexiglas B 32mm L 70mm Materialstärke 1.3mm VPE 1 Stück		

Mikroschalter

Halterungen

				
1				
GEV-Nr.	347797	Vergl.-Nr.	223109000105 GMW1030-P23 P180M30ASL-YL-P23 SEE30FYLH-SABCOG-P23	
Beschreibung	Halterung für Mikroschalter L 165mm B 65mm VPE 1 Stück			
Zubehör für	347797			
	GEV-Nr.	347794	Vergl.-Nr.	223119000028 GMW1030-P247 P180M30ASL-YL-P247 SEE30FYLH-SABCOG-P247
Hebel für Mikroschalter L 28mm klein ID ø 5mm B 22mm VPE 1 Stück				
	GEV-Nr.	347795	Vergl.-Nr.	223119000027 GMW1030-P246 P180M30ASL-YL-P246 SEE30FYLH-SABCOG-P246
Hebel für Mikroschalter L 45mm mittel ID ø 5mm B 22mm VPE 1 Stück				
	GEV-Nr.	347796	Vergl.-Nr.	223119000026 GMW1030-P245 P180M30ASL-YL-P245 SEE30FYLH-SABCOG-P245
Hebel für Mikroschalter L 63mm groß ID ø 5mm B 22mm VPE 1 Stück				

Hebel

			
1			
GEV-Nr.	347794	Vergl.-Nr.	223119000028 GMW1030-P247 P180M30ASL-YL-P247 SEE30FYLH-SABCOG-P247
Beschreibung	Hebel für Mikroschalter L 28mm klein ID ø 5mm B 22mm VPE 1 Stück		
			
1			
GEV-Nr.	347795	Vergl.-Nr.	223119000027 GMW1030-P246 P180M30ASL-YL-P246 SEE30FYLH-SABCOG-P246
Beschreibung	Hebel für Mikroschalter L 45mm mittel ID ø 5mm B 22mm VPE 1 Stück		



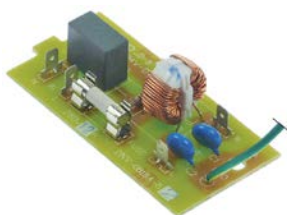

			
1			
GEV-Nr.	347796	Vergl.-Nr.	223119000026 GMW1030-P245 P180M30ASL-YL-P245 SEE30FYLH-SABCOG-P245
Beschreibung	Hebel für Mikroschalter L 63mm groß ID ø 5mm B 22mm VPE 1 Stück		

Netzfilter			
			
1			
GEV-Nr.	403184	Vergl.-Nr.	263029001216 GMW1030-C04 P180M30ASL-YL-C04 SEE30FYLH-SABCOG-C04
Beschreibung	Netzfilter für Mikrowelle Typ GMW1030 250V 50/60Hz Leiter 2 Platine Anschluss Flachstecker 6,3mm L 90mm H 20mm B 70mm Platine VPE 1 Stück Kabellänge 130mm		

			
1			
GEV-Nr.	403188	Vergl.-Nr.	263029001088 GMW1025-C04 P100M25ASL-H4-C04 SEE250H4H-SABCOG-C04
Beschreibung	Netzfilter Mikrowelle für GMW1025 250V 50/60Hz Leiter 2 Platine Anschluss Flachstecker 4,8mm L 80mm H 20mm B 40mm Platine VPE 1 Stück Kabellänge 120mm Typ DNV-0818A-5		

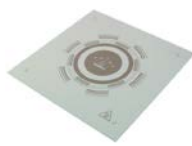
Gehäuse			
Außenteile			
			
1			
GEV-Nr.	692453	Vergl.-Nr.	403079000048 GMW1030-P240 P180M30ASL-YL-P240 SEE30FYLH-SABCOG-P240
Beschreibung	Rahmen L 484mm B 72mm H 34mm für Mikrowelle VPE 1 Stück		

Keramikplatten			
			
1			
GEV-Nr.	692350	Vergl.-Nr.	243999000108 GMW1025-P162 P100M25ASL-H4-P162 SEE250H4H-SABCOG-P162
Beschreibung	Keramikplatte L 330mm B 335mm für Mikrowelle Stärke 3.5mm für Gerät GMW1025 VPE 1 Stück		
Zubehör für	692350		
	GEV-Nr.	901698	Vergl.-Nr.
			593219000016 GMW1025-P161 P100M25ASL-H4-P161
Beschreibung	Dichtung L 330mm B 325mm Silikon für Keramikplatte VPE 1 Stück		

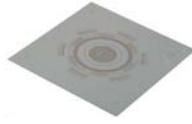
			
1			
GEV-Nr.	692462	Vergl.-Nr.	243999000113 GMW1030-P161 P180M30ASL-YL-P161 SEE30FYLH-SABCOG-P161
Beschreibung	Keramikplatte L 365mm B 353mm für Mikrowelle Stärke 4mm für Gerät GMW1030 passend für GALANZ		

Sonstiges			
			
1			
GEV-Nr.	601869	Vergl.-Nr.	213149000023 GMW1025-P04 P100M25ASL-H4-P04 SEE250H4H-SABCOG-P04
Beschreibung	Halter L 78mm B 20mm H 50mm für Kondensator VPE 1 Stück		

Türen			
Folien			
			
1			
GEV-Nr.	692451	Vergl.-Nr.	515059000119 GMW1025-P114 P100M25ASL-H4-P114 SEE250H4H-SABCOG-P114
Beschreibung	Folie L 287mm B 159mm für Tür innen Stärke 0.1mm transparent passend für GALANZ Kunststoff VPE 1 Stück		

Türscharniere

			
1			
GEV-Nr.	701250	Vergl.-Nr.	213999000705 GMW1030-P377 P180M30ASL-YL-P377 SEE30FYLH-SABCOG-P377
Beschreibung	Haken unten für Türverschluss L 51mm B 6mm H 28mm Loch ø 4.4mm VPE 1 Stück		

Türverschlüsse

			
1			
GEV-Nr.	347902	Vergl.-Nr.	GMW1025-P198 P100M25ASL-H4-P198 SEE250H4H-SABCOG-P198
Beschreibung	Kloben L 174mm B 48mm für Mikrowelle für Gerät GMW1025 passend für GALANZ Kunststoff VPE 1 Stück		

Zugfedern

			
1			
GEV-Nr.	701249	Vergl.-Nr.	575000090094 GMW1030-P118 P180M30ASL-YL-P118 SEE30FYLH-SABCOG-P118
Beschreibung	Zugfeder ø 7.3mm Gesamtlänge 25.5mm Drahtstärke ø 1mm für Türverschluss VPE 1 Stück		

Griffe und Handräder

Türgriffe

Türgriffe

			
1			
GEV-Nr.	694617	Vergl.-Nr.	213999000846 GMW1030-P34 P180M30ASL-YL-P34 SEE30FYLH-SABCOG-P34
Beschreibung	Griffstange Rohr ø 16mm L 235mm Aluminium VPE 1 Stück		

Gerätefüße und Endkappen

Steckbare Gerätefüße

			
1			
GEV-Nr.	701251	Vergl.-Nr.	223189000015 GMW1025-P26 P100M25ASL-H4-P26 SEE250H4H-SABCOG-P26
Beschreibung	Gerätefuß ø 20mm H 12mm Einbau ø 8mm Einbaumaß 19mm Gesamthöhe 19mm Kunststoff VPE 1 Stück		

Dichtungen

Spezialdichtungen

für Mikrowellen

			
1			
GEV-Nr.	901698	Vergl.-Nr.	593219000016 GMW1025-P161 P100M25ASL-H4-P161 SEE250H4H-SABCOG-P161
Beschreibung	Dichtung L 330mm B 325mm Silikon für Keramikplatte VPE 1 Stück		

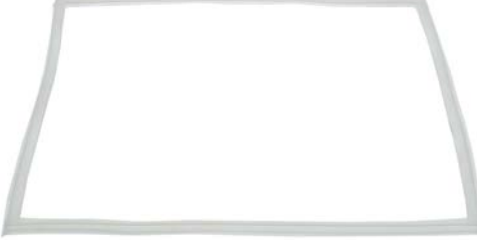
			
1			
GEV-Nr.	902161	Vergl.-Nr.	P161
Beschreibung	Dichtung L 365mm B 360mm Silikon für Keramikplatte VPE 1 Stück für GMW1030		

Federn

Zugfedern

			
1			
GEV-Nr.	701249	Vergl.-Nr.	575000090094 GMW1030-P118 P180M30ASL-YL-P118 SEE30FYLH-SABCOG-P118
Beschreibung	Zugfeder ø 7.3mm Gesamtlänge 25.5mm Drahtstärke ø 1mm für Türverschluss VPE 1 Stück		

A

Anlegethermostate 3,3

E

Elektrozubehör 8

F

Filter 7

G

Geräteleitungen 8

H

Heißluftmotoren 6

Heißluftventilatoren 6

HV-Kondensator 7

K

Kabel 8

Kondensatoren & Entstörfilter 7

L

Lampen 4

Leistungshalbleiter 4

Lüfter 6

M

Magnetrons 4

Mikroschalter 3

Mikrowellenlampen 4

Motoren 7

R

Radiallüfter 7

S

Schalter und Taster 3

T

Thermostate 3

Transformatoren 5